



FFRS series

M18 IP69K photoelectric sensors with background suppression for harsh environments



features

- Stainless steel housing AISI316L (DIN 1.4404)
- protection degree: IP68-IP69K
- Complete protection against electrical damages
- New sensitive adjustment through sensor housing: on object or on background
- Special model with reduced spot dimension and good performance on reflective material
- Approvals: CE and cULus Listed



web contents



- Application notes
- Photos
- Catalogue / Manuals



M18 IP69K with background suppression

code description^(*)

FFRS / BP - 1E

series	FF	M18 photoelectric sensor with IP69K protection degree
emission	R	Visible red LED emission
function	S	Background suppression 30...130 mm
output	0	NO/NC selectable output, 4 wires
	B	NO+NC selectable output, 4 wires
PNP / NPN output	P	PNP output
	N	NPN output
housing	1	Stainless steel housing, axial optic
plug	E	M12 plug exit
		Standard version
version	V5	Smooth housing
	77	Special model for shiny object and 60...100 mm sensing distance
	V577	Special model with smooth housing for shiny object and 60...100 mm sensing distance

(*) ATEX models available, contact our Sales Dept. for further information.

available models

functions	housing	adjustment	distance (mm)	4 wires			
				NPN NO + NC	PNP NO + NC	NPN NO + NC	PNP NO + NC
background suppression	AISI 316L (DIN 1.4404) thread housing	Teach-In	30...130	FFRS/0N-1E	FFRS/0P-1E	FFRS/BN-1E	FFRS/BP-1E
	AISI 316L (DIN 1.4404) smooth housing			-	-	FFRS/BN-1EV5	FFRS/BP-1EV5
background suppression for shiny object	AISI 316L (DIN 1.4404) thread housing		60...100	FFRS/0N-1E77	FFRS/0P-1E77	FFRS/BN-1E77	FFRS/BP-1E77
	AISI 316L (DIN 1.4404) smooth housing			-	-	FFRS/BN-1EV577	FFRS/BP-1EV577



	FFRS/**_**	FFRS/**_**77
nominal sensing distance	30...130 mm	60...100 mm
scanning range (Sd)	30...130 mm (white paper)	60...100 mm (white paper)
emission	red (660 nm)	
hysteresis	≤ 10 % (white paper)	≤ 15 % (white paper)
repeatability	10 %	
tolerance	+ 15 / - 5 % Sn	
supply voltage	10...30 Vdc	
ripple	≤ 10 %	
no-load supply current	50 mA (Val = 30 V)	
output current	100 mA	
leakage current	≤ 10 µA @ Vdc max	
output voltage drop	2 V max. IL = 100 mA	
output type	NPN or PNP selectable output LO/DO or complementary output NO + NC	
switching frequency	1kHz	400 Hz
power on delay	200 ms	
temperature range	- 25°C...+ 80°C (without freeze); short exposure with not working sensor 15 min to 100°C	
power supply protections	polarity reversal, transient	
output protection	short circuit (autoreset)	
protection degree	IP67; IP68 (1 m, 7 days); IP69K (according 40050 part 9) ⁽¹⁾	
EMC	in conformity with the EMC Directive according to EN 60947-5-2	
external light interference	5,000 lux (incandescent lamp), 10,000 lux (sunlight)	
LEDs	Green: ON: teach function available OFF: teach function blocked Fast flashing: teach in progress Yellow: output state (O models) light State (B models)	
housing material	stainless steel	
exit plug	PA12	
optic material	PA12	
approvals	CE, cULus, IP68, IP69K, ECOLAB, Diversey	
weight (approximate)	60 gr	

⁽¹⁾ Protection guaranteed only with plug cable well mounted

response diagram

LO/DO selectable output

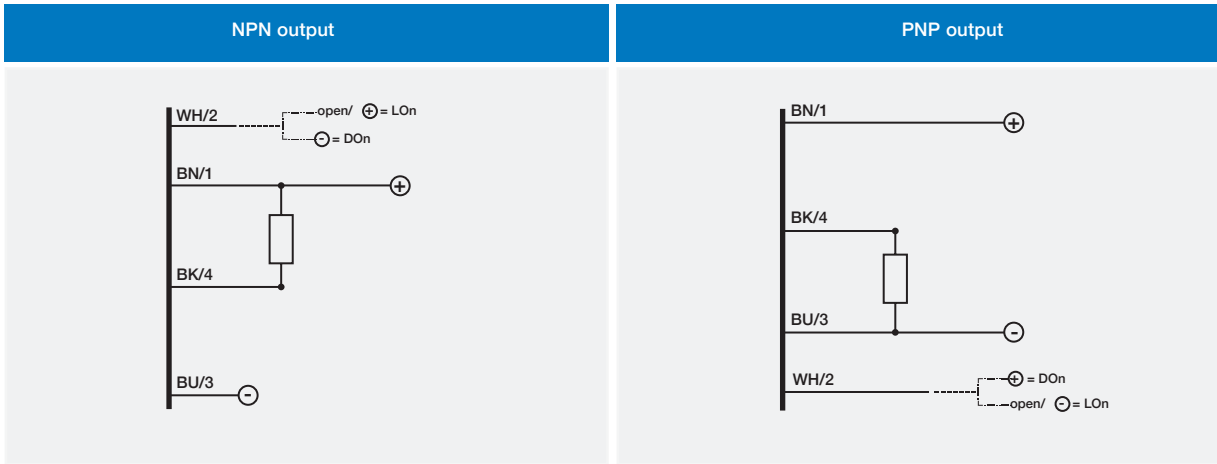

- BN brown
- BU blue
- BK black
- WH white

response diagram

NO+NC complementary output

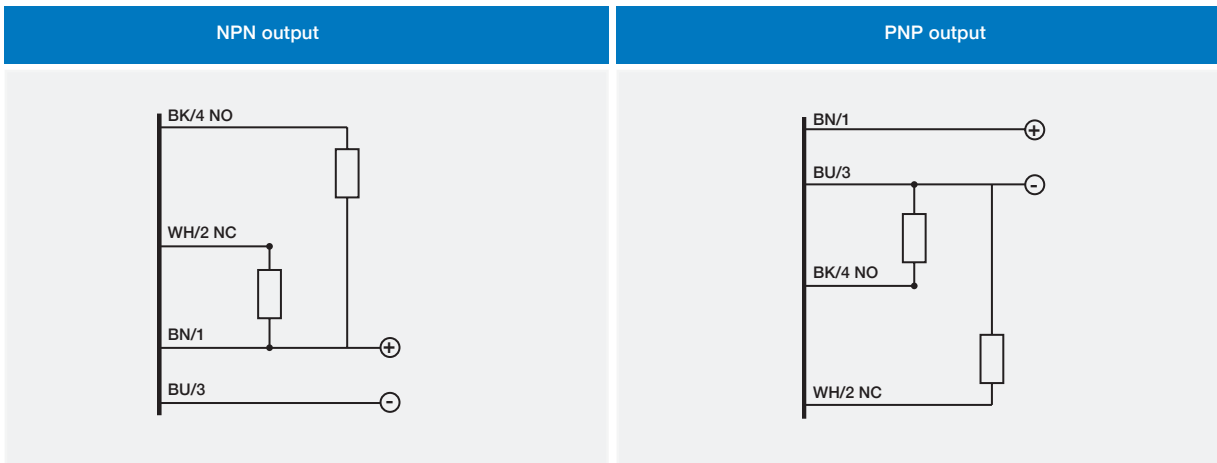

- BN brown
- BU blue
- BK black
- WH white

plug

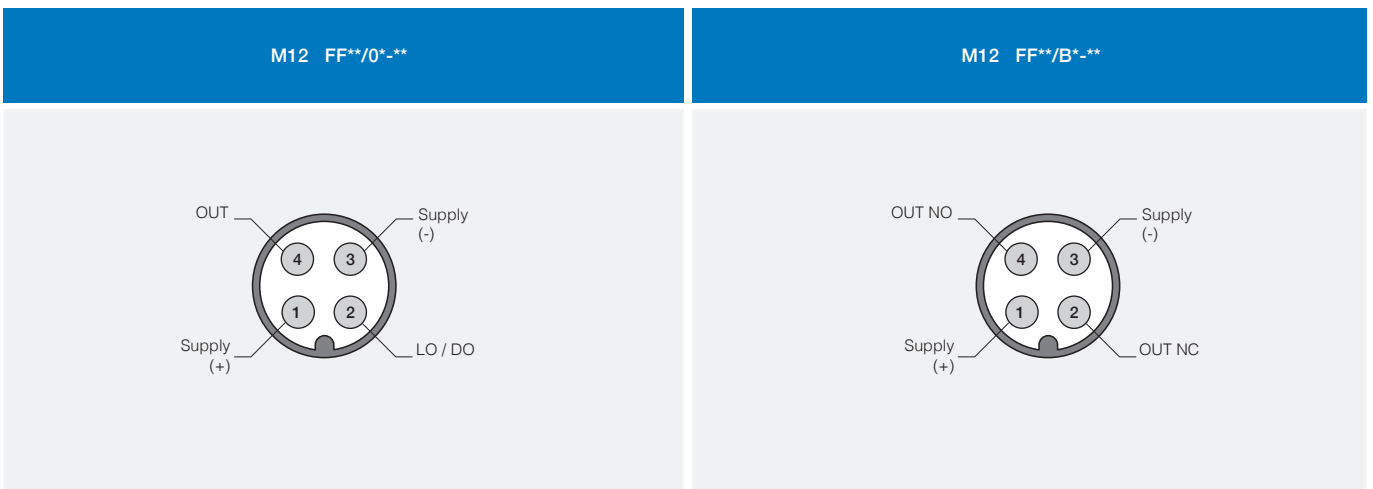



response diagrams

background suppression models

M18 IP69K
for harsh environments

FFRS/**-** spot dimension

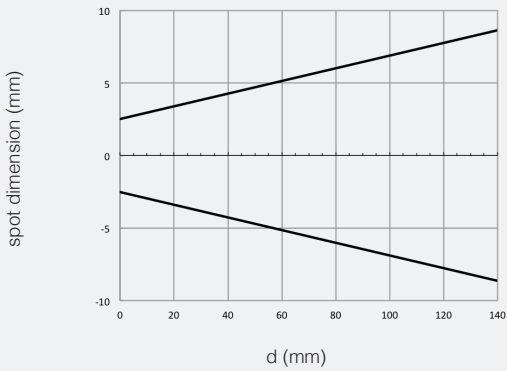

FFRS/**-** parallel displacement

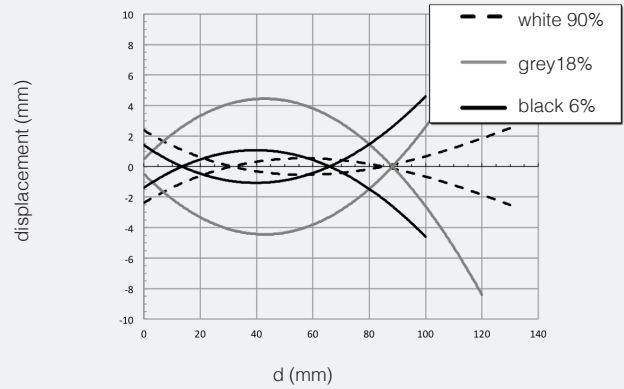

FFRS/**-** reduction of sensing distance

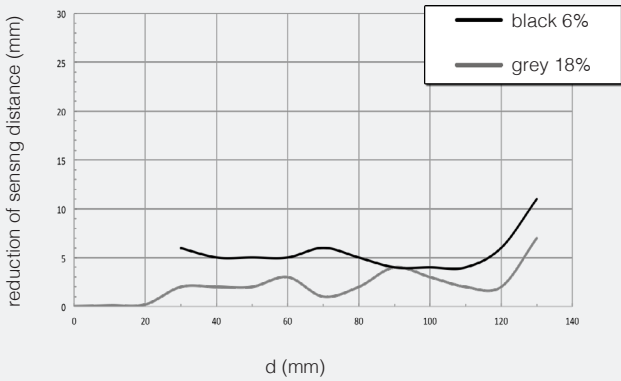

FFRS/**-77 spot dimension

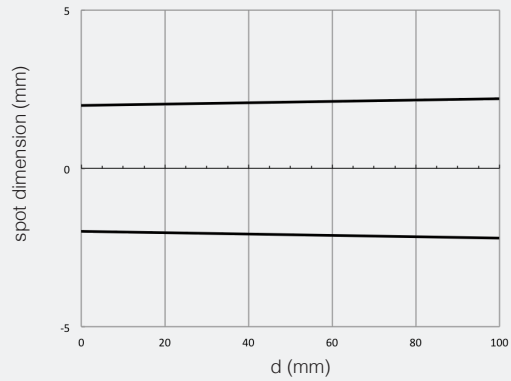

FFRS/**-77 parallel displacement

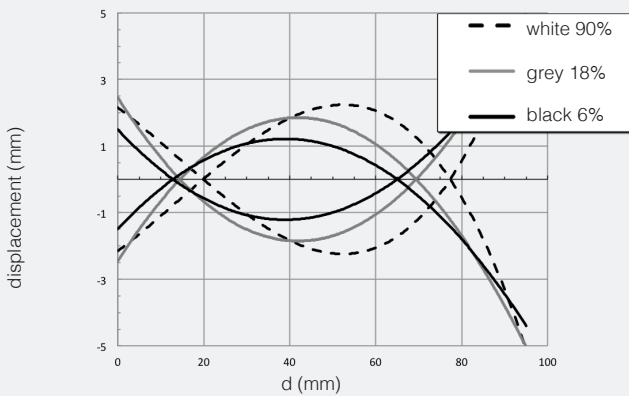

FFRS/**-77 reduction of sensing distance

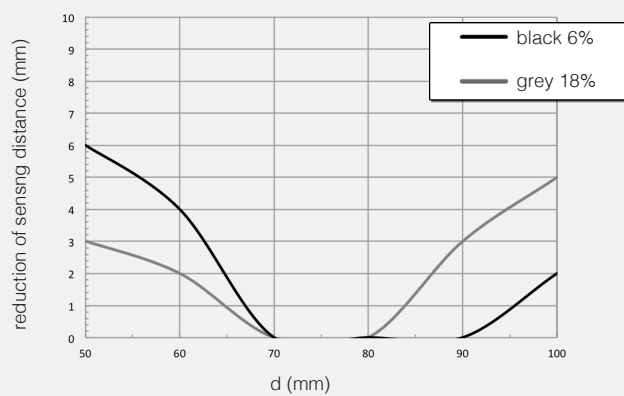

response diagrams

background suppression models



FFRS/**-** spot dimension

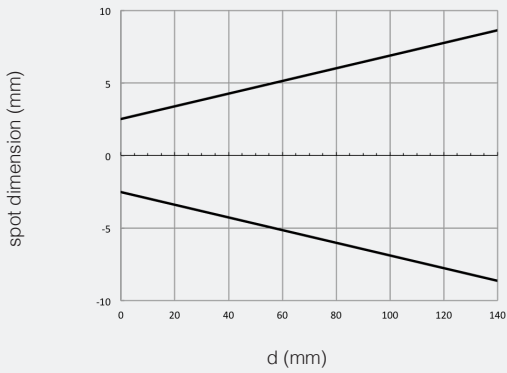

FFRS/**-** parallel displacement

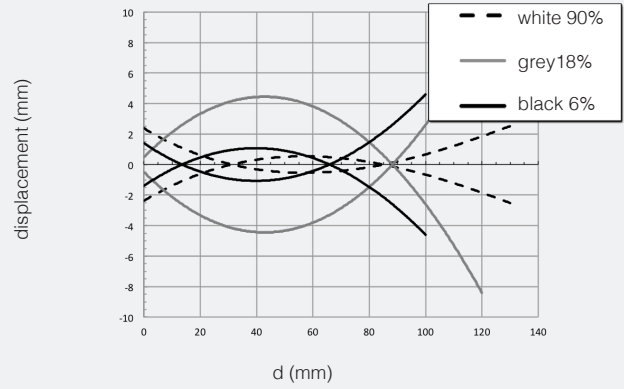

FFRS/**-** reduction of sensing distance

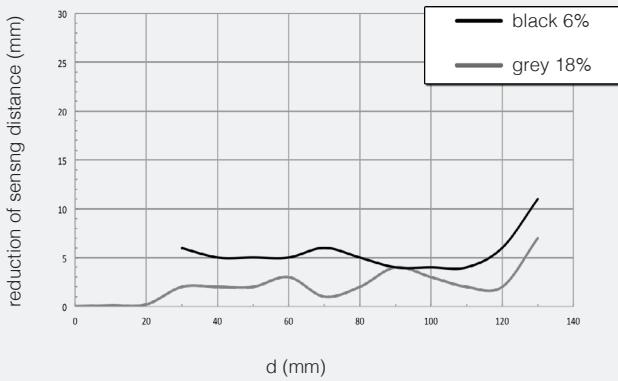

FFRS/**-**77 spot dimension

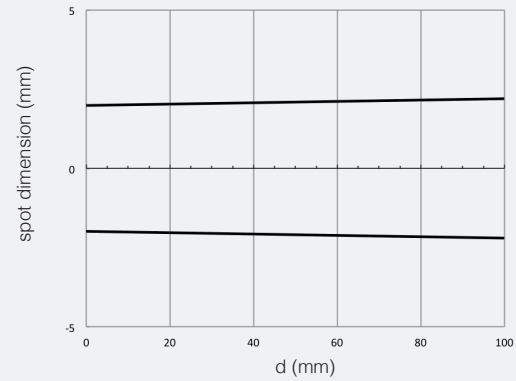

FFRS/**-**77 parallel displacement

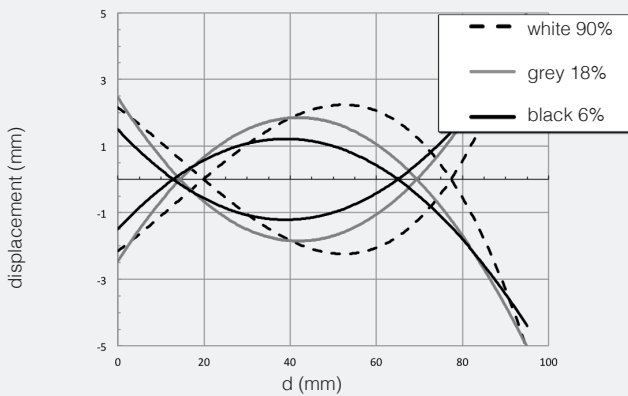

FFRS/**-**77 reduction of sensing distance

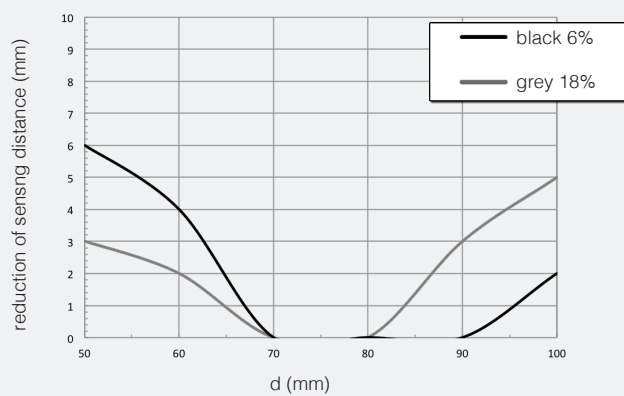



dimensions (mm)

M18 IP69K
for harsh environments

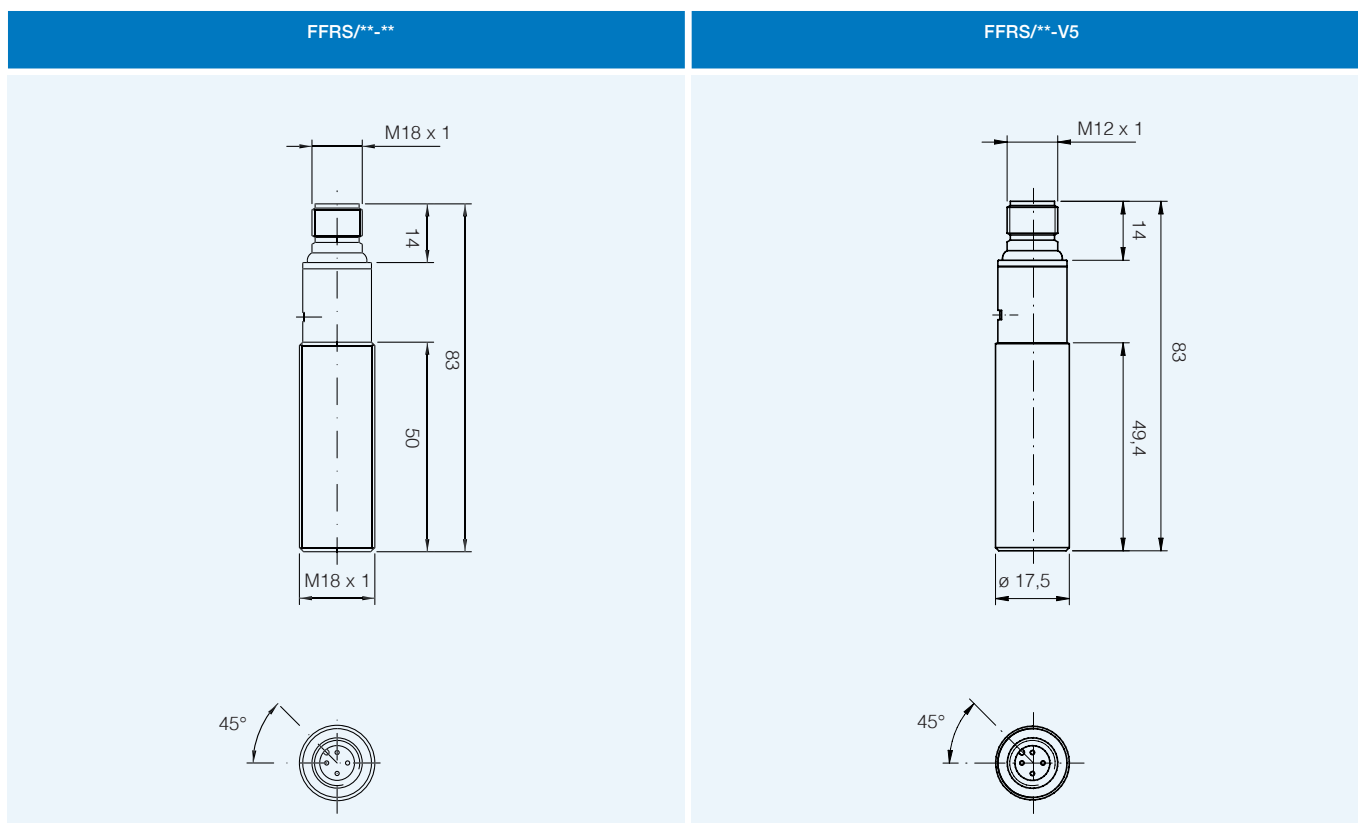

dimensions (mm)

accessories included in all metallic models

